



Heavy Duty Ag Lights



TLA2701
TLA2716

- Dual lights provide running lights and turn signals
- Meets ASABE S279.13 including 4cp to side on amber lens
- Mounting: vertical, horizontal or inverted horizontal
- Vertical or inverted horizontal mounting require reversing RH & LH
- Light with 4-pin plug also provide brake lights

TLA2700	LED 3-pin plug, left hand	\$85.95
TLA2701	LED 3-pin plug, right hand	\$85.95
TLA2715	LED 4-pin plug, left hand w/ brake light	\$85.95
TLA2716	LED 4-pin plug right hand w/ brake light	\$85.95

Heavy Duty Ag Light Kits



TLA2770

TLA2776

- Provides turn signals and running lights
- Mounting: Vertical, horizontal or inverted horizontal
- Vertical or inverted horizontal mounting require reversing RH & LH
- TLA2770- Includes LED TLA2700 & TLA2701, 35' wishbone wire harness, 5' convoluted tubing, 7HD plug & tri-plugs to plug into lights
- TLA2776- Includes LED TLA2715 & TLA2716, 46' round wishbone cable, 7HD plug & quad-plugs to plug into lights, and 4- 90 lb pull magnets. Provides brake lights. Can be permanently mounted.

TLA2770	LED economy light kit	\$252.00
TLA2776	LED deluxe light kit with magnets	\$352.95

Single LED Ag Light



TLA2722

- Amber front and back
- Mounting: vertical, horizontal or inverted horizontal

TLA2722	Single LED Ag Light 2 pin plug, Amber	\$60.95
---------	---------------------------------------	---------

Pedestal Lights



TLS050



TLS150

- Pedestal mount
- Commonly used on tractor fenders
- TLS050-Chrome die cast housing.

TLS050	RED/AMBER LED 4" Round Pedestal light	\$44.95
TLS150	RED/AMBER Incandescent 4" Round	\$8.19

Rectangle LED Work Lights



TLW481

TLW482

TLW684

TLW682

- Rugged aluminum housing with stainless bracket and bolt
- TLW481- 18W, 18" wire leads, 90° flood, 3 yr warranty
- TLW482- 18W, 36" wire leads, 5 yr warranty
- TLW684- 27W, 18" wire leads, 3 yr warranty
- TLW682- 40W, 28" lead with Deutsch connectors, 5 yr warranty

TLW481	6½" x 1¾"	6 LED	10-30V	1,320 lumens	\$36.95
TLW482	6" x 5"	6 LED	12-24V	1,350 lumens	\$48.95
TLW684	4¼" x 4¼"	9 LED	10-30V	1,900 lumens	\$45.95
TLW682	3" x 3"	4 LED	12V	3,039 lumens	\$57.95

Round LED Work Lights



TLW080

TLW084

- 3 year warranty
- TLW080- Rugged aluminum housing, 12-24 V
- TLW084- Stainless bracket, Rugged aluminum housing, 10-30 V

TLW080	4½" round, rugged 6 LED,	1350 lumens	\$36.95
TLW084	4½" round, rugged 9 LED,	1900 lumens	\$49.95

Halogen Work Lights



- ½" hollow mounting bolt with 6" wires

TLA580	4" x 6" rectangle, flood beam	\$27.00
--------	-------------------------------	---------



LED Light Bars & Strip Lighting



LED Light Bars



- Heavy duty aluminum housing
- 12 or 24 VDC
- Hardwire, 16" leads
- Mounting hardware included
- Lifetime LED warranty! Waterproof rating: IP65

LED LIFETIME WARRANTY
NO BULBS TO REPLACE EVER!

ITEM#	length	flood LED's	spot LED's	raw lumens	effective lumens	Price
TLW495	9"	8	4	2,520	1,550	\$62.95
TLW496	13"	8	16	5,000	2,700	\$68.95
TLW497	22"	24	16	7,500	4,521	\$109.95
TLW498	33"	32	28	12,600	6,777	\$156.95

Magnetic LED Work Light



- 5" clear acrylic lens
- 6 LED, 1,350 lumens output
- 12-24 volts, 1.5 amp
- Shock resistant & waterproof
- Stainless steel mounting bracket and fasteners
- Includes magnetic base and 30' power cord

TLW480 LED Work Light \$55.95

Swivel LED Work Light



- Aluminum housing
- 12-24 V DC
- Hardwired
- Mounting hardware included
- 3800 raw lumens/ 1988 effective lumens
- 3 year warranty

TLW089 Swivel LED Work Light, flood beam \$75.95

LED Load Equalizer



- Use when upgrading incandescent turn signals to LED lights
- Makes turn signal flash at proper flash rate
- Easy plug and go! One required per circuit, 50W, 60hm in-line resistor. Note: Resistors will get very warm, please mount to metal

TLP999 LED load equalizer \$10.95

LED Strip Lighting w/ Switch



- In-line on/off touch switch for easy use in tool boxes, etc.
- Easy to install with self-adhesive backing
- Sealed. 5-year warranty.

TLSL61019 18" Cool White Strip Light \$29.95

LED Strip Lighting



- Easy to install self-adhesive backing
- Sealed. 5-year warranty. 1 year warranty if applied to exterior surfaces

TLSSL61018	18" Cool White Strip Light	\$26.95
TLSSL61024	24" Cool White Strip Light	\$34.95
TLSSL61036	36" Cool White Strip Light	\$42.95

In-Line Fuse Holder



HEFH10 Fuse holder, up to 10 AMP ATC (fuse not included) \$4.99

Heavy Duty Turn Signal Flasher



Incandescent trailer lights often require a heavier flasher. Replaces 12 volt, 2 terminal flashers on most vehicles.

HEFHD Heavy Duty Flasher \$5.99

Pulse Preventer



- The Pulse Preventer prevents 4 way flashers from activating brake controls by utilizing a diode. Normally not needed.

HE2180S Pulse Preventer \$24.95

LED Beacon Light



- Height: 3.7"
- 2 flash patterns
- 40 Amber LED's
- Base: 5/4" diameter
- Dome: 3 1/2" diameter
- Permanent or Magnetic mount
- Includes 10 ft coiled wire with a cigarette lighter plug.



TLV061 LED Beacon Light \$36.95

LED Portable Strobe Light



- Magnetic mount
- 2-D batteries (not included) last 100+ hours
- Clear dome, Amber LED's
- 4" wide x 4 3/4" high
- Can automatically switch off in daylight



TLV064 24 LED AMBER strobe light \$35.95

Municipal Strobe Light



- 12-48V
- Dual Flash
- 80 Flashes/min
- 8 joule intensity
- Cast black powder coated aluminum base
- 3 bolt or pipe mount, fasteners and rubber gasket included
- Gell coated circuit board, 2 yr warranty



TLV170 Permanent Mount, 6 1/2" base x 6 1/2" height \$86.95

Interior Dome Lights



TLI411



TLI412

- TLI412 has a built-in on/off switch

TLI411 5 3/4" x 2 3/4" x 3/4" 9 LED Sealed Dome Light \$12.95

TLI412 7 1/4" x 4 3/8" x 1 3/4" 9 LED Sealed Dome Light \$12.95

LED Mini Light Bar



- Clear lens, 56 high-power amber LED's
- Low-profile design
- Clear acrylic lens
- 10 selectable flash patterns
- Permanent mount or 4 rubber-covered magnetic mounts
- 8 1/2' cord with "on-off" switch and flash pattern selector
- 15" L x 8 1/4" W x 3" H

TLV478 LED AMBER Mini Light Bar \$239.95

LED Mini Light Bar



- Clear lens, 24 amber LED's
- 10 selectable flash patterns
- Permanent mount or 4 rubber-covered magnetic mounts
- 9 1/2' cord with built-in flash pattern selector and cigarette plug
- 11" L x 6 1/2" W x 2 1/4" H

TLV476 LED AMBER Mini Light Bar \$106.95

Hardwire Control Switch



- 15' cable
- Up to 10 amp capacity
- Works well to hardwire TLV478 and TLV476
- On/Off button & flash pattern toggle button

TLVC20 Hardwire Control Switch \$22.95

Toggle Switch



MATS571



MATSB

- 20 Amps at 12VDC
- Standard 1 1/16" chrome handle
- Single pole. Single throw. On/off
- Weather resistant plastic coating with O-ring in stem
- MATSB- Protection against water & salt spray

MATS571 Toggle Switch w/ 8" leads \$12.95

MATSB Toggle Switch Boot, 1 1/32"-32 threads \$4.99



Wireless Light Bars

Wireless Magnetic Towing Lights



- Brake & taillights, turn signals, 4 way flashers
- 10 diodes per light (requires 8 AA batteries)
- Over 65' of wireless operation
- Standard 4-pin flat magnetic transmitter
- 29 lb pull magnets

HEMLW20 LED wireless magnetic towing light kit \$129.95

Magnetic Towing Lights



- Brake & taillights, turn signals, 4 way flashers
- Housing & lens are sonic welded to create a sealed light
- 12 diodes per light, 22 lbs pull magnets
- 20' wiring harness with standard 4-pin flat connector

HEMLL24 LED magnetic towing light kit \$79.95

The Wireless Limelight



- 14 LED's!
- Provides stop, tail, & turn lights
- Up to 10 hrs of use between charges
- Recharges from 12V DC cigarette plug (included)
- Two 90 lb pull magnets with non-scratch rubber boots included
- Lifetime warranty on LED's & electronics
- Comes complete with light bar, transmitter, charge, & instructions
- Transmitter provides approximately 1000' range.

HEMW122 22" Limelight with 4-pin round transmitter \$279.95

HEMW1227HD 22" Limelight with 7HD round pin transmitter \$279.95

HEMW12RV 22" Limelight with 7RV transmitter \$279.95

Magnetic Towing Lights



- Brake & taillights, turn signals, 4 way flashers
- 20' main harness
- 8 lb pull magnets
- Use for under 80" wide loads

HEML20 Towing light kit, incandescent, 4-flat plug \$39.95

Magnetic Towing Lights



HEMLL

Wireless Light Bar



- Provides stop, tail and turn lights and amber strobe light
- 2 switches: "On/Off" to power up the system & 1 for the strobe light.
- 12V DC charge cord available but not included.
- In the event your batteries fail you can simply plug a cord into the connector and continue to use the light.
- Powerful magnets on the bottom, straps on the top and a handle for ease of carrying.
- Transmitter can be ordered with your choice of plug (\$15 extra)

HEMMB 25" LED wireless light bar, 7 HD round pin \$529.95

- Brake & taillights, turn signals, 4 way flashers
- 30' main cord
- 7" between lights
- 70 lb pull magnets

HEMLL LED towing kit with case, 4 round plug \$165.95

HEMLL4F LED towing kit with case, 4-flat plug \$169.95

Low-Profile Strobe Lights



TLV467

- 6 CREE diodes
- Synchronize up to 12 units
- 19 flash patterns
- 4½" wide x 1¼" high x ½" deep
- 3 year limited warranty

TLV466	Amber Strobe	12V	\$31.95
TLV467	Amber/White Strobe	12V	\$31.95

Low-Profile Strobe Lights



TLV468

- Synchronize up to 8 units
- TLV468- 71 flash patterns (70 flashing/1 steady)
- TLV469- 92 flash patterns (88 flashing/4 steady)
- 4¾" wide x 1¼" high x ½" deep
- Lifetime LED warranty!

TLV468	6 LED Amber Strobe	12/24V	\$49.95
TLV469	12 LED Amber/White Strobe	12/24V	\$67.95

LED High Power Strobe Lights



- Aluminum Base & CLEAR Polycarbonate lens
- 10-30VDC, draws less than 1 amp per flasher
- 4¾" x 2" base, 4½" mounting holes
- Can be wired to strobe (or solid function- use your own flasher)
- Quad Strobe Flash (4 flash/second) or "solid light"

TLV460	AMBER Strobe Light	\$49.95
--------	--------------------	---------

LED High Power Strobe Light



- Aluminum Base & CLEAR Polycarbonate lens
- 10-30VDC, 40% more power and wattage than TLV460
- 2 flash patterns: Slow-single and Fast-quad
- 4¾" x 2" base, 4½" mounting holes

TLV461	AMBER Strobe Light	\$43.95
--------	--------------------	---------

LED Strobe Control



- Turn any standard LED light into a strobe
- 4 alternating (wig-wag), 2 simultaneous, & 1 random pattern.
- Powers up to 5 amps
- Comes with detailed installation instructions

TLVB	LED Strobe Control Box	\$60.95
------	------------------------	---------

LED Magnetic Hazard Flashers



TLV274



2-position magnet mount

- Excellent for farm equipment, trucks, cars, boats, trailers, etc.
- Uses 4 AA batteries (not included) last 20-30 hours
- Visible over 1 mile away
- 7" x 3", 2-position (back/bottom) 70 lb magnet

TLV224	24 LED RED flasher	\$37.95
TLV274	24 LED AMBER flasher	\$37.95

LED Magnetic Hazard Flashers



TLV222



TLV272

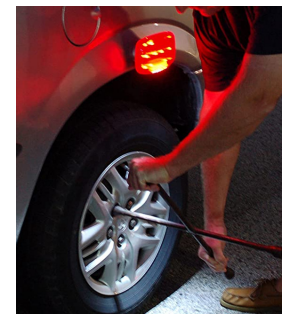

TLV221

- Excellent for farm equipment, trucks, cars, boats, trailers, etc.
- Uses 4 AA batteries (not included) last 20-30 hours
- Visible over 1 mile away
- 6" x 4", two 25 lb magnets

TLV222	18 LED RED flasher	\$27.95
TLV272	18 LED AMBER flasher	\$26.95
TLV221	18 LED RED flasher with work light	\$24.95

LED Strobe Lights



TLV260



TLV070

- 12 volt DC (TLV070: 12-24V)
- 3 year warranty
- TLV260: quad-flash strobe, 240FPM, includes grommet and plug
- TLV070: six flash strobe, 198FPM, includes grommet & plug

TLV260	6" Oval AMBER 13 LED strobe	\$39.95
TLV070	4" Round AMBER 24 LED strobe	\$38.95



4" Round Stop/Tail/Turn Lights



TLS001

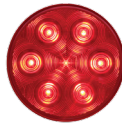

TLS016



TLS010



TLS030



TLS018



TLS013



TLS022



TLS060



TLS068



TLW014



TLW016



TLW010



TLW011



TLS110

4" Round Light Diagrams

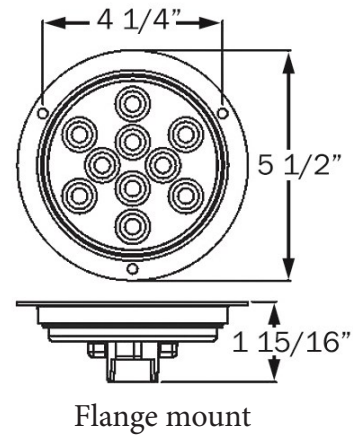
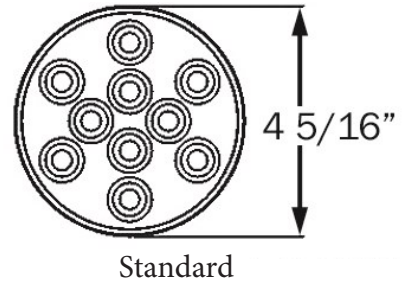

4" Round Light Accessories



TLP210



TLB160



TLB168

• Mounting bracket, rubber grommet, & connector are sold separately.

TLS001	Red	ONE LED light	\$7.09
TLS016	Red	7 LED light	\$10.39
TLS010	Red	10 LED light	\$13.29
TLS030	Red	12 LED light, X-shaped Light Guide™	\$17.95
TLS018	Red	21 LED light	\$18.29
TLS013	Red	10 LED flange mount light	\$16.29
TLS022	Red 8/White 4	LED S/T/T and backup light, requires two 3-pin plugs	\$28.95
TLS060	Amber	10 LED light	\$15.95
TLS068	Amber	21 LED light	\$18.29
TLW014	White	10 LED utility light	\$23.95
TLW016	White	6 LED DOT approved backup light	\$18.95
TLW010	White	10 LED DOT approved backup light	\$28.95
TLW011	White	36 LED DOT approved backup light	\$43.95
TLS110	Red	Incandescent light, 4 1/4" x 2 1/16"	\$5.59

TLG160	Rubber mounting grommet for 4 1/2" hole	\$1.99
TLB160	Mounting bracket	\$5.29
TLP212	3-pin "straight" plug connector	\$2.00
TLP210	3-pin "right angle" plug connector	\$1.79
TLB663	Single light box	\$36.95
TLB664	Single light box with 2" round on side	\$48.95
TLB167	Double light box	\$57.95
TLB168	Triple light box	\$85.95

6" Oval Stop/Tail/Turn Lights



TLS211



TLS224



TLS230

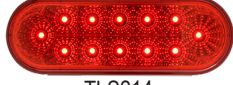

TLS214

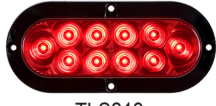

TLS213



TLS222



TLW214



TLW211



TLS260



TLS266



TLS213



TLW213

6" Oval Light Diagrams

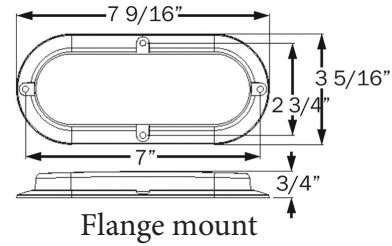
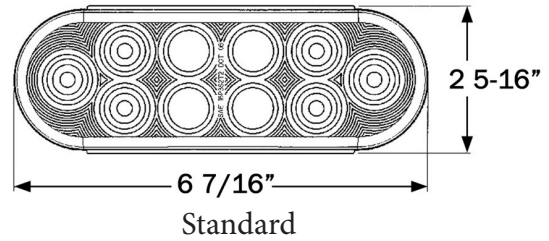

6" Oval Light Accessories



TLG210



TLB310



New!



TLP210



TLB387



TLB388



TLB163

•Mounting bracket, rubber grommet, & connector are sold separately

TLS201	Red	ONE LED light	\$6.99
TLS216	Red	6 LED light	\$9.99
TLS211	Red	10 LED light	\$12.95
TLS224	Red	16 LED light, Glolight	\$19.95
TLS230	Red	12 LED light, X-shaped Light Guide™	\$17.95
TLS214	Red	12 LED Miro-flex light	\$18.95
TLS218	Red	48 LED light	\$24.95
TLS213	Red	10 LED surface mount light with wire lead	\$13.95
TLS215	Red	10 LED light w/ clear lens	\$15.95
TLS222	Red 8/White 4	LED S/T/T and backup light, requires two 3-pin plugs	\$28.95
TLS260	Amber	10 LED light	\$16.49
TLS268	Amber	48 LED light	\$31.09
TLS263	Amber	10 LED flange mount light with wire lead	\$15.19
TLS266	Amber	9 LED mid-ship turn signal	\$18.95
TLW214	White	10 LED utility light	\$22.95
TLW213	White	10 LED utility light, flange mount, wire leads	\$20.95
TLW216	White	6 LED DOT approved backup light	\$18.95
TLW210	White	10 LED DOT approved backup light	\$28.95
TLW211	White	36 LED DOT approved backup light	\$43.95
TLS310	Red	Incandescent light	\$7.79
TLS360	Amber	Incandescent light	\$7.09

•TLB386/387/388/166: Unpainted for easy welding

TLG210	Rubber mounting grommet for 6.85" x 2.50" hole	\$1.79
TLB310	Mounting bracket	\$4.59
TLP212	3-pin "straight" plug connector	\$2.00
TLP210	3-pin "right angle" plug connector	\$1.79
TLB383	Single light box	\$30.95
TLB384	Single light box with 2" round on side	\$33.95
TLB386	Single light box	unpainted \$13.95
TLB387	Single light box with 2" round on side	unpainted \$13.95
TLB388	Single light box with 3/4" round on side	unpainted \$13.95
TLB163	Double light box	\$50.95
TLB166	Double light box	unpainted \$22.95
TLB253	Triple light box	\$72.95



Stop, Tail, Turn Lights

Square Stop/Tail/Turn Lights



- Stud mount- 2" between studs
- TLS600/601, TLS610/611, TLS620/621 are water proof
- TLL713: Retail pack includes tail & side marker lens set

TLS710	Right	w/o license light	over 80"		\$8.09
TLS711	Left	with license light	over 80"		\$8.49
TLS715	Right	w/o license light	over 80"	submersible	\$7.99
TLS716	Left	with license light	over 80"	submersible	\$7.99
TLS720	Right	w/o license light	under 80"		\$7.29
TLS721	Left	with license light	under 80"		\$7.59
TLS610	Right	w/o license light	over 80"	18 LED	\$23.95
TLS611	Left	with license light	over 80"	18 LED	\$27.95
TLS600	Right	w/o license light	under 80"	ONE LED	\$10.95
TLS601	Left	with license light	under 80"	ONE LED	\$11.49
TLS620	Right	w/o license light	under 80"	11 LED	\$19.95
TLS621	Left	with license light	under 80"	11 LED	\$22.95
TLB782	Left	with license light	mounting light box		\$9.99
TLB783	Right	w/o license light	mounting light box		\$9.99
TLL713	Replacement lens kit for TLS710/711/715/716				\$6.09
TLL611	"Box" side replacement lens for over 80"				\$1.95

Square Stop/Tail/Turn Kits



- Includes 25' of trailer wiring with 4-flat
- LED kits have Lifetime Warranty
- TLK711 is not submersible
- TLK610 is waterproof

TLK711	Incandescent Light Kit, with side markers	\$25.95
TLK610	LED Light Kit, 4¾"W x 4¾"H x 2¼"D	\$59.95

LED Stop/Tail/Turn

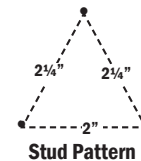

- Hardwire
 - 16 LED red tail light, 22 LED white backup, 4 LED white license
- | | | | | |
|--------|-------|-----------------------|-----|---------|
| TLS638 | Right | Without license light | LED | \$46.95 |
| TLS639 | Left | With license light | LED | \$50.95 |

Difference between waterproof and submersible?

- Waterproof lights are sealed and will not let water inside.
- Submersible lights are designed for submersion and have a drain hole at the lowest point.
- Please make sure your wiring connections are sealed so water cannot get in through the wires.

Rectangle Stop/Tail/Turn Kits

Optronics

LED LIFETIME WARRANTY
NO BULBS TO REPLACE EVER!

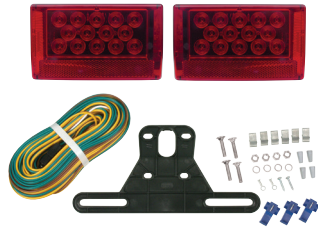

- Includes 25' of trailer wiring with 4-flat
- LED kits have Lifetime Warranty
- Waterproof

TLK411 LED Light Kit, 6¹/₁₆"W x 3³/₈"H x 2¹/₄"D **\$76.95**

5⁵/₁₆" Stop/Tail/Turn Lights

Optronics



TLS420

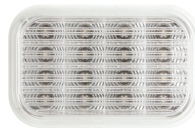

TLW420

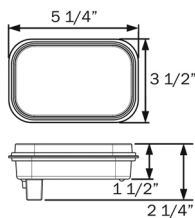

- 5⁵/₁₆" x 3⁷/₁₆"
- Rubber grommet, & connector are sold separately.

TLS420	Red	12 LED light	\$23.95
TLW420	White	16 LED light	\$35.95
TLS520	Red	Incandescent light	\$7.79
TLG520		Rubber mounting grommet	\$2.89
TLP212		3 pin "straight" plug connector	\$2.00
TLP210		3 pin "right angle" plug connector	\$1.79

License Plate Lights & Brackets

Optronics

LED LIFETIME WARRANTY
NO BULBS TO REPLACE EVER!



TLW485



TLW465



TLW464



TLW585



TLW570



TLW180



TLB710



TLB712

•TLB710/712- Fits behind 2" C-C stud STT lights; accepts TLW585

TLW485	5 LED light & poly bracket, 3 ³ / ₈ " C-C mount	\$13.09
TLW465	2 LED light, chrome body, 2" C-C mount	\$8.19
TLW464	2 LED light, black body, 2" C-C mount	\$7.49
TLW585	Light with studs on 1 ³ / ₄ " centers	\$5.49
TLW570	Armored light w/ 2" C-C mount	\$4.69
TLW180	Snap-in light, chrome plated, fits 1 ¹ / ₄ " hole	\$3.29
TLB710	Black poly license plate bracket	\$1.29
TLB712	Zinc plated steel license plate bracket	\$3.49

Stop/Tail/Turn Lights

Optronics

LED LIFETIME WARRANTY
NO BULBS TO REPLACE EVER!



TLS410



TLS412

- Waterproof
- Studmount- 2" between studs
- TLS412 & TLS413 are Miro-Flex Design

TLS410	Right	w/o license light	18 LED	over 80"	\$23.95
TLS411	Left	with license light	18 LED	over 80"	\$27.95
TLS412	Right	w/o license light	14 LED	over 80"	\$23.95
TLS413	Left	with license light	14 LED	over 80"	\$28.95



JKD 7RV
Front Cable
See page 127



Thinline Stop/Tail/Turn Light Bars



TLS440



TLS441

- Only 5/8" thick! Surface mount with 14/8" mounting holes
- Provides brake, tail lights, and LT or RT (does not provide both!)

TLS440	15 x 1 3/8" 11 LED S/T/T Light Bar	\$15.95
TLS441	15 x 1 3/8" 11 LED S/T/T Light Bar, Clear Lens	\$15.95

Stop/Tail/Turn Light Bars



TLS430



TLS435

- 1" thick, surface mount with 16 1/8" mounting holes.
- Provides brake, tail lights, and LT or RT (does not provide both!)

TLS430	17 x 1 3/8" 11 LED S/T/T Light Bar	\$15.95
TLS435	17 x 1 3/8" 28 LED GloLight S/T/T Light Bar	\$22.95

4 Function LED Bar



- Provides BOTH RT & LT, brake, and tail lights.
- Surface mount with 14 1/2" mounting holes

TLS434	15 1/2 x 1 3/8" 4 function 11 LED Bar	\$26.95
--------	---------------------------------------	---------

ID Lights with Harness



- These 3 lights install into standard 3/4" holes
- Harness installs with .180 in. male bullet connectors

TLM002	7.5' harness with three 3/4" ID lights, 3 LED per light	\$24.95
--------	---	---------

Incandescent Identification Light Bars



- TLM340 - stainless steel

TLM241	15 1/16" red incandescent bar, 14 3/8" c/c mounting holes	\$8.99
TLM340	14 1/4" red incandescent bar, 8 1/2" c/c mounting holes	\$13.95

LED Identification Light Bars



TLM245



TLM240

- TLM240 - stainless steel

TLM245	17" Red 3 LED, 16 1/8" c/c mounting holes	\$15.95
TLM240	14 1/4" Red 9 LED, 8 1/2" c/c mounting holes	\$21.95

LED Identification Light Bars



- Replace individual lights with TLM410/510

TLM247	15 15/16" Red LED bar, 7 1/2" c/c mounting holes 1 diode per light, black plastic base, retail poly pack	\$14.95
TLM248	15 15/16" Red LED bar, 7 1/2" c/c mounting holes 3 diodes per light, black plastic base	\$19.95
TLM249	16 1/2" Red LED bar, 16 1/16" c/c mounting holes 3 diodes per light, stainless steel base	\$20.95

ID Harness



- Three 2-pin plugs with 51" wire lead
- Replacement harness for TLM247/248/249

TLM030	Replacement ID light bar wiring harness	\$5.49
--------	---	--------

Trailer Lights



2" Round Marker Lights



TLM010 TLM060 TLM014

TLM016	Red	1 LED	\$5.09
TLM013	Red	3 LED	\$8.59
TLM010	Red	10 LED	\$7.99
TLM014	Red	9 LED Miro-flex	\$8.99
TLM017	Red	3 LED clear lens	\$8.59
TLM110	Red	Incandescent	\$2.89
TLM066	Amber	1 LED	\$5.09
TLM063	Amber	3 LED	\$8.59
TLM060	Amber	10 LED	\$7.99
TLM064	Amber	9 LED Miro-flex	\$7.99
TLM067	Amber	3 LED clear lens	\$8.59
TLM160	Amber	Incandescent	\$3.89
TLB111	Branch deflector bracket		\$2.29
TLB112	L mounting bracket		\$8.99
TLG010	Rubber mounting grommet for 2 5/16" hole		\$1.19
TLP010	2-pin plug connector		\$1.29

PC-rated or Miro-flex?

- PC-rated lights are designed to be visible 90° front and back of the center line of the light.
- Miro-flex lights have a built-in specially shaped reflector around the diodes to increase brightness



4"x1 1/4" Marker Lights



•TLB530 has 3" c/c mounting holes

TLM525	Red	Incandescent 2 bulb	\$3.49
TLM425	Red	3 LED	\$6.79
TLM427	Red	4 LED, PC rated	\$7.99
TLM428	Red	4 LED, Miro-Flex	\$8.09
TLM575	Amber	Incandescent 2 bulb	\$3.49
TLM475	Amber	3 LED	\$6.79
TLM477	Amber	4 LED, PC rated	\$7.99
TLM478	Amber	4 LED, Miro-flex	\$8.09
TLM530	Red/Amber	Incandescent fender light	\$4.89
TLM430	Red/Amber	10 LED fender light	\$8.69
TLB530	4"x1 1/4" surface mount bracket w/ plug		\$2.59
TLB532	4"x1 1/4" surface mount fender bracket w/ plug		\$2.79

2 1/2" Round Marker Lights



TLM025 TLM170 TLM030



TLM020	Red	2 LED	\$6.49
TLM023	Red	3 LED	\$8.79
TLM030	Red	13 LED	\$8.99
TLM025	Red	8 LED reflex	\$6.59
TLM120	Red	Incandescent	\$3.79
TLM070	Amber	2 LED	\$6.49
TLM073	Amber	3 LED	\$8.79
TLM075	Amber	8 LED reflex	\$6.59
TLM080	Amber	13 LED	\$8.99
TLM170	Amber	Incandescent	\$2.89
TLG020	Rubber mounting grommet for 2 3/4" hole (most common)		\$1.99
TLG030	Rubber mounting grommet for 3" hole		\$1.75
TLB121	Branch deflector bracket		\$3.29
TLB120	L mounting bracket		\$3.99
TLP010	2-pin plug connector		\$1.29

Marker Lights for 3/4" Hole



TLM005 TLW005 TLG006 TLM008

•These lights install into 3/4" hole

TLM005	Red	2 LED, with grommet	\$4.99
TLM006	Red	2 LED, with grommet, clear lens	\$6.99
TLM008	Red	1 LED, 1 1/4" round light with 3/4" grommet	\$9.99
TLM055	Amber	2 LED, with grommet	\$4.99
TLM056	Amber	2 LED, with grommet, clear lens	\$6.99
TLM058	Amber	1 LED, 1 1/4" round light with 3/4" grommet	\$9.99
TLW005	White	2 LED, with grommet	\$7.59
TLG005	Replacement Grommet for 3/4" light		\$0.89
TLG006	Stainless Steel Trim Ring for 3/4" Light		\$2.49



4"x 2" Marker Lights



•These lights are surface mount with 3" c/c holes

TLM310	Red	Incandescent, oval	\$3.29
TLM220	Red	6 LED light, oval	\$8.99
TLM222	Red	10 LED light, bullseye, PC rated	\$11.99
TLM360	Amber	Incandescent, oval	\$3.29
TLM270	Amber	6 LED light, oval	\$8.99
TLM272	Amber	10 LED light, bullseye, PC rated	\$11.99

Square Stud Mount Marker Lights

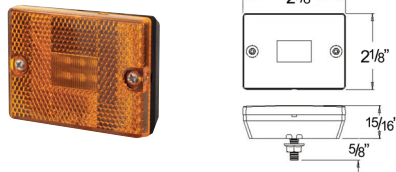

- Reflex lens
- 2-wire
- 1/4" stud size

TLM520	2"x3"	Red	Incandescent stud mount	\$3.69
TLM570	2"x3"	Amber	Incandescent stud mount	\$3.69
TLM420	2"x3"	Red	6 LED stud mount	\$8.49
TLM470	2"x3"	Amber	6 LED stud mount	\$8.49

LED Marker Lights

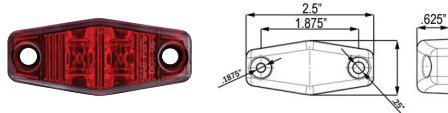

•Self-grounding.

TLM210	2 1/2"x1"	Red	2 LED surface mount, 1 7/8" c/c	\$7.69
TLM260	2 1/2"x1"	Amber	2 LED surface mount, 1 7/8" c/c	\$7.69
TLG260	2 1/2"x1"	Foam mounting gasket for TLM210/260		\$0.39

Fender Lights

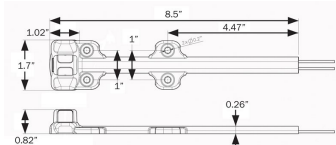

TLM536



TLM535

•TLM534/535: Incandescent bulbs

TLM536	LED Reversible Amber/Red Fender light	\$6.79
TLM534	3 7/8"x8 1/2" right fender light, over 80"	\$8.69
TLM535	3 7/8"x8 1/2" left fender light, over 80"	\$8.79

2 1/2"x1 1/4" Marker Lights

TLM460

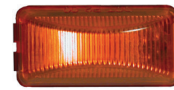

TLM465

TLG510



TLB410

•TLB410 has 2" c/c mounting holes

•TLW460 has 2 lead wires

TLM510	Red	Incandescent	\$3.79
TLM410	Red	3 LED, PC rated	\$7.49
TLM560	Amber	Incandescent	\$3.79
TLM460	Amber	3 LED, PC rated	\$7.49
TLM465	Amber	3 LED, miro-flex	\$8.59
TLW460	White	2 LED	\$6.95
TLG510	Rubber mounting grommet for 3.313" x 1.938" hole		\$1.49
TLB410	2 1/2"x1 1/4" surface mount bracket, black		\$1.99
TLB414	2 1/2"x1 1/4" surface mount bracket, self ground, chrome		\$2.39
TLP010	2-pin plug connector		\$1.29
TLP001	1-pin plug connector for use with TLB414		\$0.69

2 1/8"x1 1/8" Marker Lights

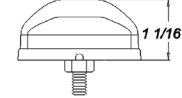
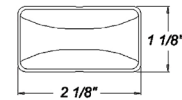

•1/4" stud size

•Has a chrome ring around the edge

TLM413	Red	3 LED stud mount, with wire lead	\$6.99
TLM463	Amber	3 LED stud mount, with wire lead	\$7.09

LED Marker Lights

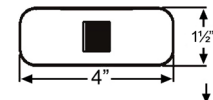

•Reflex lens

•2-wire

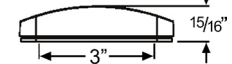

TLM418	4"x1 1/2" Red	6 LED surface mount, 3" c/c	\$8.49
TLM468	4"x1 1/2" Amber	6 LED surface mount, 3" c/c	\$8.49

Incandescent Marker Lights



TLM540



•Incandescent bulbs with reflex lens

•Surface mount, 3" c/c holes

TLM540	4"x1 1/2" Red	\$2.79
TLM590	4"x1 1/2" Amber	\$2.79

Conspicuity Tape & Reflectors



Conspicuity Tape

ORALITE®

TCTRW3150

TCTRW5150

TCTRW10150

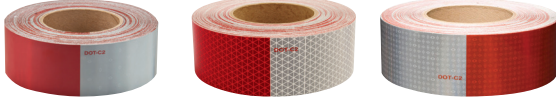

- Red/White reflective tape
- 11" red - 7" white
- DOT approved
- *TCTRW5151: Kiss cut every 18"
- Custom printed available, minimum 450 rolls, contact for details

TCTRW3150	V42 Conspicuity Tape-3 Year	150' roll	\$85.95
TCTRW5150	V92 Conspicuity Tape-5 Year	150' roll	\$104.95
TCTRW5151	V92 Conspicuity Tape-5 Year	150' roll*	\$104.95
TCTRW10150	V82 Conspicuity Tape-10 Year	150' roll	\$123.95
TCTRW518	V92 Conspicuity Tape-5 Year, 18" piece		\$1.39
TCTRW530	V92 Conspicuity Tape-5 Year, 30' roll		\$23.95

Conspicuity Tape

ORALITE®

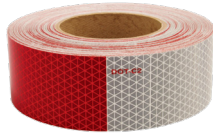

- Red/White reflective tape
- 6" red - 6" white
- DOT approved

TCTRW5158	V92 Conspicuity Tape-5 Year, 150' roll	\$104.95
-----------	--	----------

Conspicuity Tape Retail Packs

ORALITE®



- Red/White reflective tape
- 18" pieces, 11" red - 7" white
- DOT approved

TCTRW5185	V92 Conspicuity Tape-5 Year	5pc pack	\$6.59
TCTRW5186	V92 Conspicuity Tape-5 Year	25pc pack	\$31.95

Reflector stickers

ORALITE®



TLR914

TLR964

- Red or amber reflector stickers
- 2" x 3½" rectangles
- 7-year warranty
- DOT approved

TLR963	Reflector sticker	Each	Amber	\$0.79
TLR913	Reflector sticker	Each	Red	\$0.79
TLR964	Reflector sticker	100/Roll	Amber	\$59.95
TLR914	Reflector sticker	100/Roll	Red	\$59.95

White Conspicuity Tape

ORALITE®

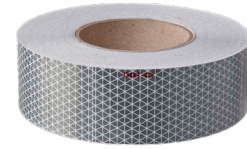

- Solid white reflective tape
- DOT approved

TCTRW5154	V92 Conspicuity Tape-5 Year, 150' roll	\$104.95
-----------	--	----------

Reflector

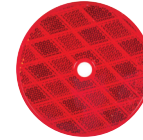

- Screw-on Reflectors

TLR912	3½" Round Reflector, RED	\$1.39
--------	--------------------------	--------

Emergency Warning Triangles



- Weighted base
- Three-in-one compact case

MERT	1 kit of 3 triangles with plastic storage case	\$39.95
	3 kits or more (price each)	\$37.95

POD Hazard Warning Lights

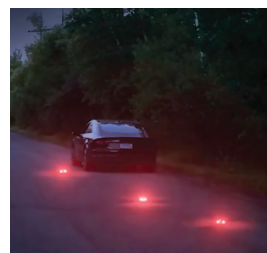

- Visible ¼ mile away in daylight conditions!
 - Weatherproof: use in rain or snow
 - 9 illumination modes, including 350 lumens work lamp
 - 3 AAA batteries (not included)
 - Versatile mounting options include swivel hook and magnetic base
- | | | |
|--------|---------------------------------|---------|
| TLV025 | 2-pack POD Hazard Warning Light | \$29.95 |
|--------|---------------------------------|---------|